







LEGEND

-  PRESSURE GAUGE
-  CHECK VALVE
-  PLUG VALVE
-  FLOW METER
-  PIGGING STATION
-  FORCE MAIN
-  GRAVITY SEWER

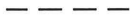
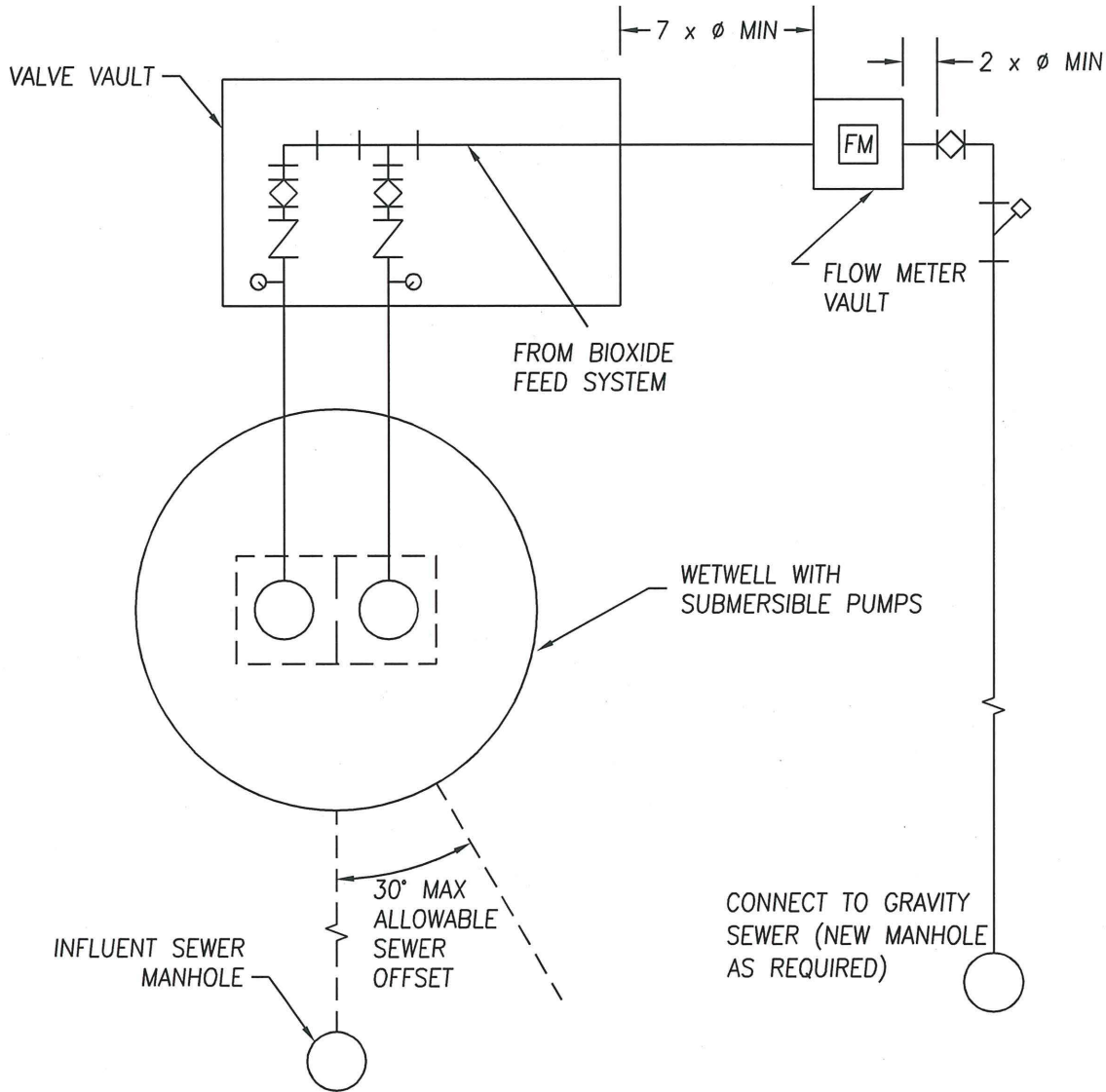

SITE PIPING SCHEMATIC

PLAN #

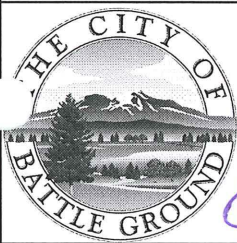

CITY OF BATTLE GROUND
APPROVED

Jan Adams 3-28-07
CITY ENGINEER DATE

REVISIONS:	DATE:	DRAWN:	DESIGNED:
1	2/23/07	JMH	MCH

SS-6.1